



PROVINCIAL DEPARTMENT OF EDUCATION NORTH WESTERN PROVINCE

THIRD TERM TEST - 2020
MATHEMATICS - I

Grade 10

02 Hours

Name / Index No. :

- Answer all the questions on this paper it self.
- Each question in part A carries 2 marks and each question in part B carries 10 marks.

Part - A

01. If $4.5 \times 4.5 = 20.25$, find the value of $\sqrt{20}$.

02. If five men work for three days to complete $\frac{1}{4}$ of a certain task, find the whole task in men days.

03. If the perimeter of the given sector is **25 cm** and arc length is **11 cm**, find it's radius.

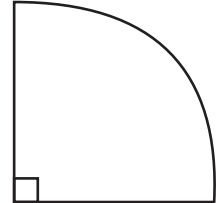

04. Expand. $(2x + 3)^2$

05. Find the value of x .

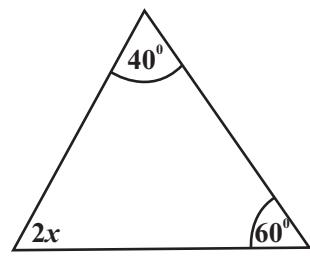

06. Write the set $A = \{x : x \text{ is an odd number } . 1 \leq x < 10\}$ by listing elements.

07. Solve. $\frac{8+x}{5} = 2$

-
08. When importing vehicles, customs duty of **40%** of it's value should be paid. Find the amount has to be paid as duty when importing a vehicle worth of **Rs. 450 000**.
-

09. A rectangular shaped label is pasted as completely covered the curved surface area of the given cylinder. Find the length and breadth of the label.

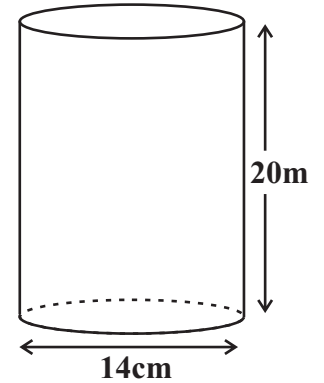

-
10. Find the value of x .

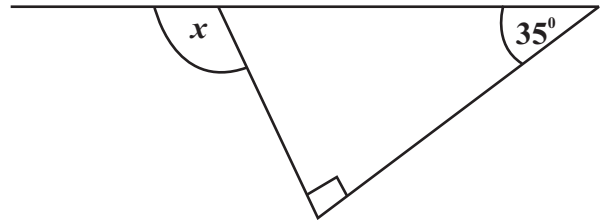

-
11. A and B are two mutually exclusive events. If $P(A) = \frac{1}{2}$, $P(B) = \frac{1}{3}$ find $P(A \cap B)$.
-

12. Make ' a ' as the subject of the formula, $v^2 = u^2 + 2as$
-

13. If the area of the shaded face of the prism given in the figure is 18cm^2 . Find the volume of the prism.

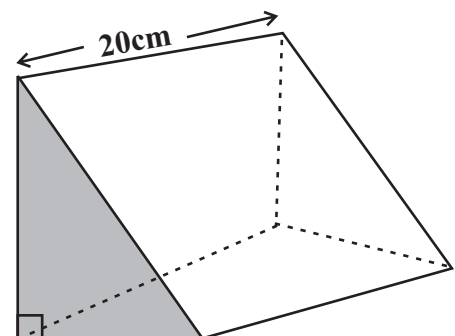

14. Select and write the pair of congruent triangles and write the case of congruency.

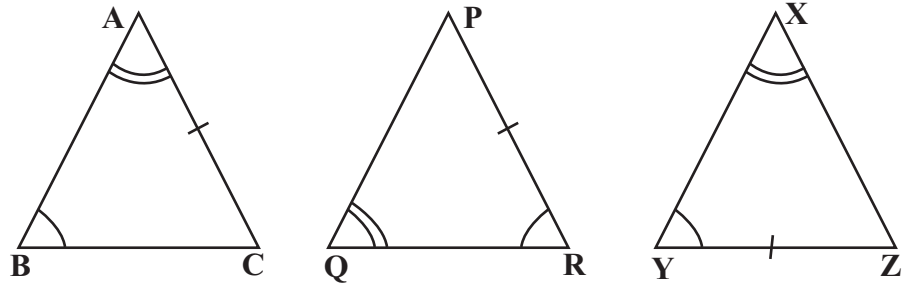

15. Find the equation of the straight line passes through the points (3, 10) and (0, 1).

16. Write two necessities for the quadrilateral ABCD to be a parallelogram.

i) $\angle AOC = \dots\dots\dots$

ii) $\angle ABC = \dots\dots\dots$

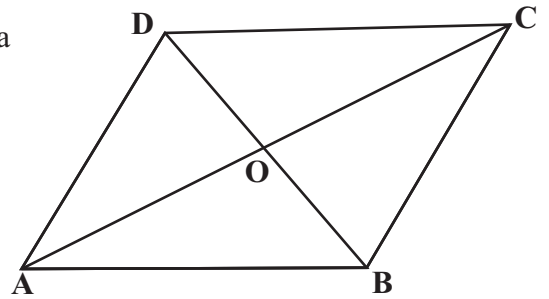

17. Factorize. $x^2 + x - 20$

18. According to the data given in the figure,

i) Write the relationship between AB and OX.

ii) If $AX = OX$, find the length of AB.

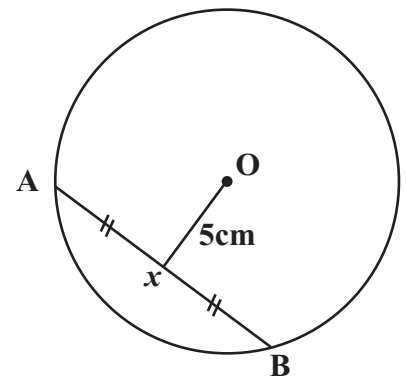

19. A and B are two points away from 10m each other. Using the knowledge of loci obtained the location of point P and Q which are equidistance to the points A and B and 6m away from the point A.

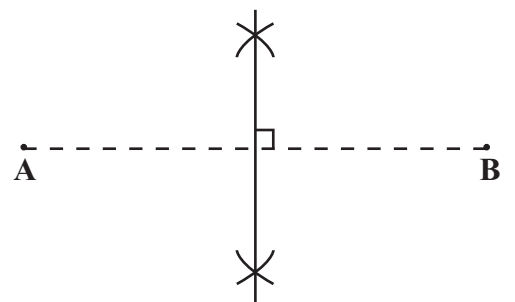

20. Write $10^{0.3010} = 2$ in logarithmic form.

21. According to the data given in the figure, find the value of \hat{ACB} .

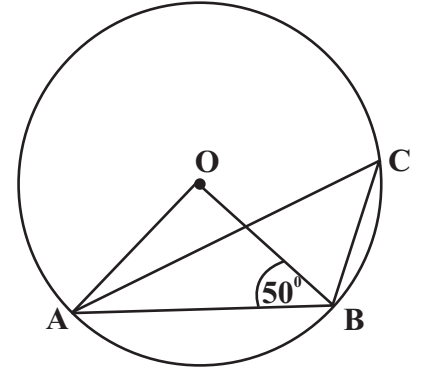

22. Find the time taken by a motor car which is travelling at the uniform speed of 60 kmh^{-1} to travel the **150km**.

23. Find the L.C.M. of $6x^2$, $2xy^2$, $10y^2$

24. The mean of the deviation of a frequency distribution is 12.4 and it's assumed mean is 18. Find the actual mean of the frequency distribution.

25. **AC** is a diameter of the given circle. If $\hat{DAC} = 52^\circ$.
Find the value of \hat{DBA} .

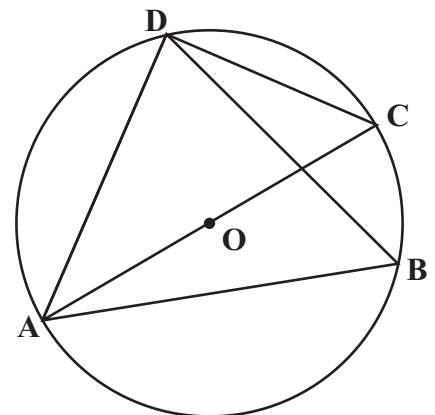

Part - B

- (01) $\frac{1}{8}$ of the passengers came by a flight were Indians. $\frac{5}{14}$ of the remainders were Europeans. Remaining passengers are Sri Lankans.
- (i) Write the number of Europeans as a fraction of total number of passengers.
- (ii) Express the number of Sri Lankans as a fraction of total number of passengers.
- (iii) $\frac{2}{3}$ of the Sri Lankans are women. If 90 Sri Lankan women came, find the total number of passengers came on this flight.
- (iv) When entering to this country Rs. 8 000 is charged for a foreigner as visa fee. Find the total visa amount received from indians who arrived on this flight.

- (02) For an exhibition the way of separating the school premisses for the sections of Commerce, Art and Science is shown in the above figure.

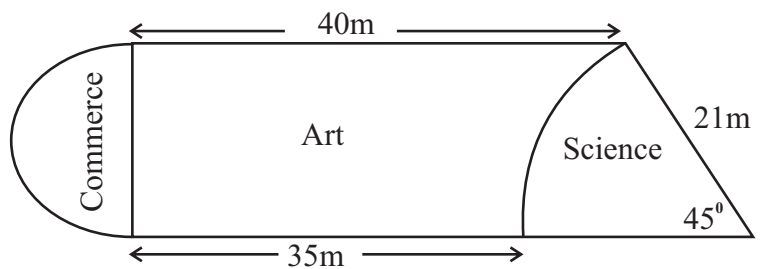

- (i) Find the length of the curved boundary of the semi-circular land area.
- (ii) Find the perimeter of the exhibition land area.

(iii) Find the area of the land separated for the science section.

(iv) Find the area of the land separated for the art section.

(v) By separating the art and commerce sections, draw a road with the area of 28m^2 with measurements on the above figure.

(03) A business institute that sells vehicles pays Rs. 6000 as rates for a quarter, in 2019. The local government authority charges 12% of the annual assessed value as rates.

(i) Find the annual assessed value of the business institute.

(ii) For the year 2020, the annual assessed value of the business institute is increased than the previous year by 10%. Find the annual assessed value of the business institute in 2020.

(iii) If 15% of discount was given for the tax as the result of paying the rates within the first quarter in 2020, find the total amount paid as rates by the business institute in both 2019 and 2020.

-
- (04) Radha, Yamuna, Ganga, Kaveesha and Chathuri saved Rs. 2 coins and they put them in to a same till. A pie chart drawn to represent the number of coins put by each of them is given below.

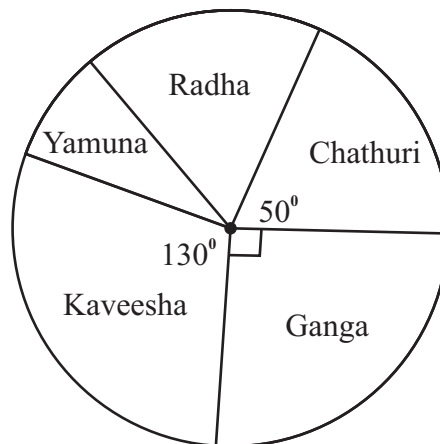

- (i) If Radha puts twice of the number of coins put by Yamuna, find the angle of the sector relevant to Radha.
- (ii) If the number of coins put by Chathuri was 10, find the number of coins put by Yamuna.
- (iii) What is the total amount in the till.
- (iv) In the next day Rs 2 coins were put in to the till as Rs. 16 by Yamuna and Rs. 20 by Radha. Find the angle of the sector relevant to Chathuri in the pie chart drawn to represent the number of coins put by each of them on this day.

(05) The total number of employees in an institution is 50. 35 of them are women. In a certain day, there were 25 people carrying umbrellas and 6 of whom were men

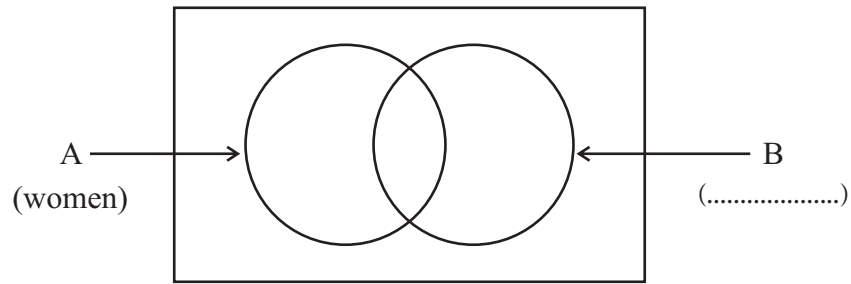

(i) Name the set B.

(ii) Represent the above information in the Venn diagram.

(iii) Explain the set $A \cap B$

(iv) How many men did not bring umbrellas?

(v) Find $n(A \cap B^c)$



PROVINCIAL DEPARTMENT OF EDUCATION NORTH WESTERN PROVINCE

THIRD TERM TEST - 2020
MATHEMATICS - II

Grade 10

03 Hours
10 minutes

Name / Index No. :

- Answer 10 questions selecting five questions from Part A and five questions from Part B.
- Write relevant steps and correct units in answering the questions.
- Each questions carries 10 marks.

Part - A

- (01) (a) The annual income of Mr. Sirisena is Rs. 1 400 000. From his income first Rs. 500 000 is tax free. On the second Rs. 500 000 a tax of 4% is charged and on the remaining amount a tax of 8% is charged. Find the total amount he should be paid as income tax.
- (b) Find the total amount that Mr. Raheem has to pay to settle a loan in 2 years, if he borrowed Rs. 80 000 at an annual simple interest rate of 9%.

- (02) An incomplete table prepared to draw the graph of the function $y = 5 - x^2$ is given below.

x	-3	-2	-1	0	1	2	3
y	-4	1	4	4	1	-4

- (i) Find the value of y when $x = 0$.
- (ii) Using the scale of 10 small divisions as one unit along the x - axis and along the y - axis draw the graph of the above function on a graph paper.
- (iii) Write the interval of values of x for which the function is decreasing positively.
- (iv) Find the roots of the equation $5 - x^2 = 0$
- (v) Write down the equation of the graph which is obtained when the above graph is shifted downwards by 2 units along the y - axis.

(03) A cylindrical vessel of base radius 28 cm has been filled with water up to 10 cm height. The water volume in the cylinder is poured to the cuboidal shaped vessel shown in the figure.

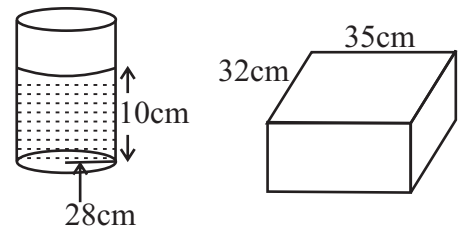

- (i) Find the volume of water in the cylindrical vessel.
- (ii) Find the height of the water level of the cuboidal shaped vessel.
- (iii) After adding 360 ml of extra water amount to the above cuboidal shaped vessel the water amount in that vessel released by a pipe which flows water at the rate of 5 litres per minute. Find the time taken to empty the vessel completely.

(04) (a) In a certain nursery, the price of a mango plant is Rs. 80 and the price of a guava plants is Rs. 50. From this nursery Samudra bought 20 number of mango and guava plants. For that she spent Rs. 1360. Build up two simultaneous equations by taking x as the number of mango plants and y as the number of number of guava plants bought by Samudra. By solving this pair of equations, find the number of mango and guava plant bought by Samudra separately.

(b) Solve the inequality $2x - 3 < 7$ and find the maximum integral value for x .

(05) In the triangular lamina ABC, the length of BC is x cm. The length of AB is 2 cm more than the length of BC..

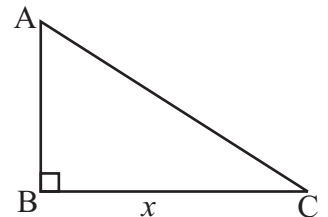

- (i) Write the length of AB in terms of x .
- (ii) If the area of the triangular lamina ABC is 24 cm^2 , build up an quadratic equation in terms of x .
- (iii) By solving the above equation find the length of BC.
- (iv) Hence, find the length of AC.

(06) Information on the number of frocks sold during a month in a certain baby care centre is given in the following table.

No. of frocks	4 - 8	9 - 13	14 - 18	19 - 23	24 - 28	29 - 33
No. of days	2	4	10	6	4	4

- (i) Write the modal class of the above distribution.
- (ii) Find the mean number of frocks sold in a day.
- (iii) If a profit of Rs. 180 is obtained on each frock sold, show that the expected minimum profit for the month is Rs. 91800.

Part - B

(07) The diagram given below shows, how Shareena placed flower pots in her garden. The flower pots are placed in a circular pattern as one pot in the middle, 4 pots in the first circle, 7 pots in the second circle.... etc.

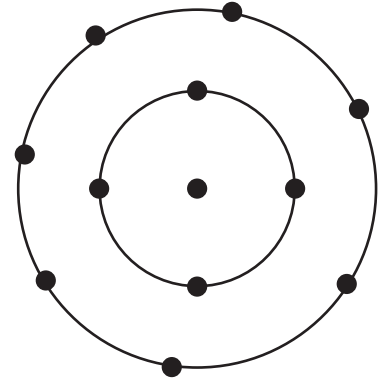

- (i) According to this pattern write the number of pots in the third circle.
- (ii) In which progression that lies the numbers of pots placed according to this pattern.
- (iii) If the flower pots were placed in ten circles, find the number of pots in the 10th circle using the formula.
- (v) Find the total number of flower pots she has placed in this pattern.

(08) Do the construction given below using a pair of compasses and a straight edge with a cm/mm scale.

- (i) Construct the triangle ABC such that $AB = 7\text{cm}$, $\hat{BAC} = 60^\circ$ and $AC = 5\text{cm}$.
- (ii) Construct a parallel line to AB through C.
- (iii) Construct the angle bisector of \hat{CAB} and mark the intersecting point of it and the above parallel line as D.
- (iv) Construct the circle taking D as the centre and DB as the radius. Then measure and write the length of DB.

(09) In the triangle ABC, the value of the $\hat{BAC} = 40^\circ$. The angular bisector of \hat{ABC} and \hat{ACB} meet at X. BXCY is a rhombus. By giving reasons find the value of \hat{BYC} .

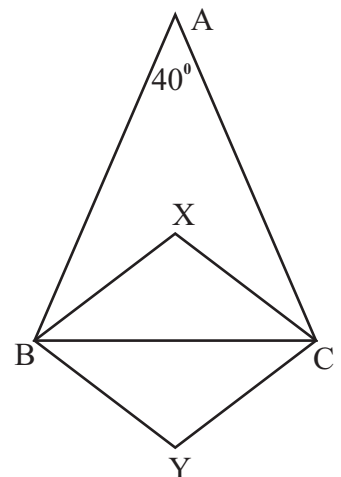

- (10) AB is the diameter of the given circle. The points P and Q are on the circle such that $PB = BQ$. The lines AB and PQ intersect at T.

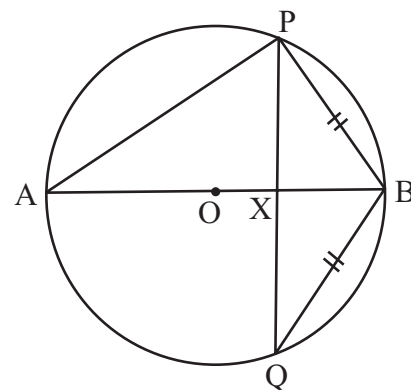

Show that,

- (i) $\hat{QPB} = \hat{PAB}$
- (ii) $AB \perp PQ$
- (iii) By joining A and Q show that $AP = AQ$.

- (11) Pradeep who is standing at point C which is 12m away from foot (A) of vertical building AB, observes the top of the building at the angle of elevation of 40° . Draw a sketch diagram to represent the above information and draw the scale diagram using the scale of 1 : 200. Then find the height of the building. (Ignore the height of Pradeep.)

- (12) There are 5 rabbits in a closed cage. 3 of them are white colour and the other 2 are brown colour. When this cage is opened by malindu one rabbit came out. Then Malindu caught that rabbit and put it to the cage and closed the cage. After that Rajitha came and opened the cage, then one rabbit came out again.
- (i) Represent the sample space relevant to the above incident in a grid.
- (ii) Find the probability of that 2 white rabbits came out in two occasions.
- (iii) In the grid, encircle the event that a brown rabbit came out in the first time and a white rabbit came out in the second time.
- (iv) An incomplete tree diagram drawn to represent the event of a rabbit came out when opening the cage by Malindu is given below. Fill in the blank of it.

Malindu is opening the cage

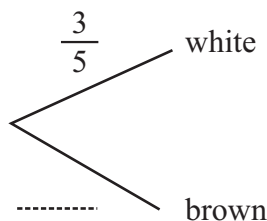

- (v) Copy the above tree diagram on to your answer script and extend it up to represent the event of a rabbit came out when opening the cage by Rajitha. Then find the probability of the event of a brown coloured rabbit is came out at least once.

