



**විසඹි පළාත් අධ්‍යාපන දෙපාර්තමේන්තුව**  
**Provincial Department of Education - NWP**

**තෙවන වාර පරීක්ෂණය - 13 ශ්‍රේණිය - 2023**  
**Third Term Test - Grade 13 - 2023**

**20 S I**

Index No.: .....

**Information And Communication Technology- I**

**02 hours**

**Instructions:**

- **Answer all the questions.**
- **Write your Index Number in the space provided in the answer sheet.**
- **Read and follow the given instructions carefully.**
- **In each of the questions 1 to 50, pick one of the alternatives from (1), (2), (3), (4), (5) which is correct or most appropriate.**

1. Which of the following statements is correct?
  - (1) Digital dividing is always between school-going and non-school-going students.
  - (2) Unauthorized copying, distribution, and use of software is called phishing.
  - (3) Plagiarism can be prevented by setting up firewalls, using passwords, not opening suspicious e-mails, and not clicking on suspicious links.
  - (4) Use and sale of any new creations for other creations without the permission of the creator is an offense punishable under the Intellectual Property Laws.
  - (5) Citing, Quoting and Referencing may prevent software plagiarism
2. A student applies for rescrutiny of his examination results through the examination department website. In order to complete the application form correctly, it is mandatory to enter the year that appeared on the examination and index number and an integer number should be entered for the index number.

Select the data validation method/methods used in this scenario.

A - Data type check	B - Presence check	C - Range check
(1) A only	(2) B only	(3) A and B only
(4) A and C only	(5) B and C only	
3. Which of the following gives the correct result of bit-wise AND and bit-wise OR operations between the two binary numbers  $10101111_2$  and  $01010101_2$  respectively in decimal form?
  - (1) 175, 85
  - (2) 5, 255
  - (3) 255, 5
  - (4) 175, 255
  - (5) 85, 5
4. What is the correct binary equivalent of decimal  $6.75_{10}$  ?
  - (1)  $110.00_2$
  - (2)  $101.11_2$
  - (3)  $1100.10_2$
  - (4)  $110.11_2$
  - (5)  $110.01_2$
5. What is the correct 2's complement binary representation of decimal  $-45_{10}$  using 8-bits?
  - (1)  $00101101_2$
  - (2)  $11010011_2$
  - (3)  $11010010_2$
  - (4)  $00110010_2$
  - (5)  $00110011_2$
6. A memory address is shown as hexadecimal 1AF. What would that address be in decimal form?
  - (1) 207
  - (2) 413
  - (3) 431
  - (4) 4001
  - (5) 4131

7. A particular command can be used to convert the text in a text file to its binary format. Assume a file contains the following text :

**List1**

Considering the **Important notes** given below, select the correct output that will result when the said command is run on that file.

- (1) 1001100 1101001 1110011 1110100 0110001 0001010
- (2) 1001101 1101010 1110100 1110101 0110111 0001010
- (3) 1001011 1101000 1110010 1110011 0110011 0001010
- (4) 1001011 1101000 1110011 1110100 1110001 0001010
- (5) 1001100 1101000 1110011 1110101 0111001 0001010

**Important notes:**

- (i) The file ends with a Line Feed character.
- (ii) Some selected rows from the 7-bit ASCII table are given below:

Character	Binary
Line Feed	0001010
Space	0100000
s	1110011
t	1110100
l	1101100
i	1101001
t	1110100

Character	Binary
I	0110001
S	1010011
T	1010100
L	1001100
I	1001001

8. Consider the following logic circuit:

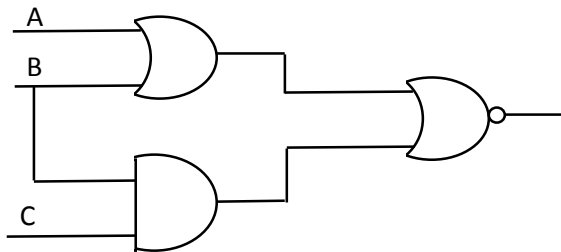

Which of the following Boolean expressions represents the output of the given logic circuit?

- (1)  $(\overline{A + B}) + \overline{BC}$
- (2)  $(\overline{A + B}) \overline{BC}$
- (3)  $\overline{(\overline{A + B}) + \overline{BC}}$
- (4)  $(\overline{AB}) + (\overline{B + C})$
- (5)  $\overline{AB + BC}$

9. Simplified Boolean expressions help to obtain simpler circuits.

Which of the following is a simplified form of  $\overline{AB} (\overline{A + B})(\overline{B + B})$ ?

- (1)  $\overline{A}$
- (2)  $\overline{B}$
- (3)  $A$
- (4)  $B$
- (5)  $\overline{AB}$

10. Below is a circuit diagram representing the Full adder. What are the correct logic gates for X and Y respectively?

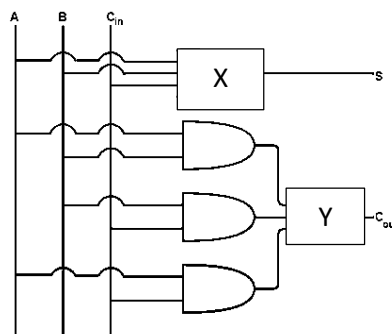

- (1) OR, XOR
- (2) XOR, XNOR
- (3) NAND, NOR
- (4) XOR, OR
- (5) NOR, XNOR

11. Linking an address in a physical memory frame corresponding to an address in a virtual memory page is called .....①.....  
 .....②..... is a storage mechanism used in the Operating system to retrieve processes from secondary storage to the main memory as pages.  
 .....③..... is caused by empty spaces created in places where processes are given to memory and then removed from memory when they are finished.

Choose the most appropriate words to fill in the blanks in the above statements.

- (1) ①→ Swapping, ②→ Mpping, ③→ Paging  
 (2) ①→ Mpping, ②→ Paging, ③→ Fragmentation  
 (3) ①→ Fragmentation, ②→ Mpping, ③→ Paging  
 (4) ①→ Mpping, ②→ Swapping, ③→ Compaction  
 (5) ①→ Paging, ②→Compaction, ③→ Fragmentation

12. Select statement/s with functions performed by the memory management unit,  
 A - Holds details of memory resources.  
 B - Converts a physical memory address to a logical memory address.  
 C- Allocates memory optimally among programs.

- (1) A only (2) A and B only (3) A and C only  
 (4) B and C only (5) All A,B and C

13. What tasks does the operating system **not perform** in terms of computer memory management?

- (1) In multiprogramming, the operating system decides which process should be sent to main memory at what time, and how much memory capacity is allocated to each operation.  
 (2) Allocating memory when a process needs it.  
 (3) De-allocates the memory when a process no longer needs it or has been terminated.  
 (4) Keeping track of what parts of memory have been allocated by processes and what parts have not yet been used.  
 (5) In a multi-program environment, deciding which process should be given to the processor at what time, and for how long.

14. Which of the following protocols is/are **not used** in the Internet layer protocols of the TCP/IP model?

- A - User Datagram Protocol (UDP)  
 B - File Transfer Protocol (FTP)  
 C - Internet Protocol (IP)

- (1) A only (2) B only (3) C only  
 (4) A and B only (5) B and C only

15. Which of the following statements is/are correct about MAC and IP addresses?

- A - A MAC address is 48 bits long and is used at the data link layer.  
 B - An IPv6 address is 128 bits long and is used at the network layer.  
 C - An IPv4 address is 32 bits long and a MAC address is 48 bits long and both of these addresses are used at the network layer.

- (1) A only (2) B only (3) C only  
 (4) A and B only (5) B and C only

16. An organization with the assigned IP address block 200.2.2.0/25 needs to create 4 subnets. Each subnet should provide for more than 20 IP addresses. Which of the following correctly lists, the number of bits needed to identify the **given network**, the total number of bits needed to create subnets, and the number of bits needed to assign a unique IP address for this requirement?

- (1) 24, 2, 5 (2) 24, 3, 5 (3) 25, 2, 5 (4) 25, 3, 5 (5) 27, 2, 5

17.

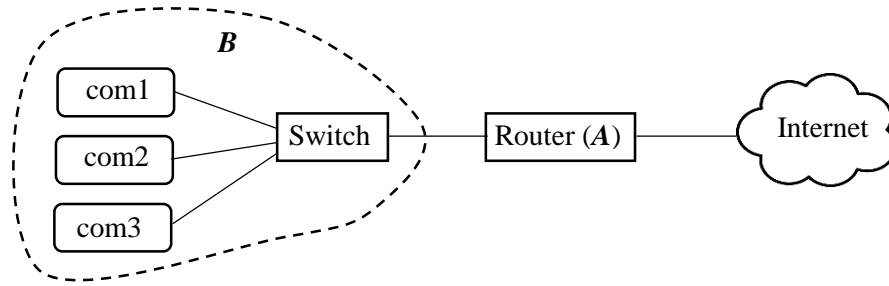

According to the above network diagram, computer network **B** is connected to the Internet through router **A**. Computers com1, com2, com3, are connected in network **B**.

According to this network diagram and description, Which option is most suitable to fill in the blank spaces **P**, **Q** and **R** respectively?

Network **B** has several computers connected to the switch and those computers are assigned private IP addresses. The default gateway of router **A** receives a .....**P**..... IP address, and the .....**Q**..... provides private IP addresses through the .....**R**..... protocol to each computer on network **B** that is connected to that router over the data transmission medium.

- (1) **P**- private ,      **Q** - internet ,      **R** - HTTP
- (2) **P**- private ,      **Q** - router ,      **R** - FTP
- (3) **P**- private ,      **Q** - router ,      **R** - DHCP
- (4) **P**- public ,      **Q** - router ,      **R** - DNS
- (5) **P**- private ,      **Q** - file server ,      **R** - DNS

18. Which of the following is correct about unguided media used in data transmission?

- A - Signals are transmitted through the atmosphere.
- B - Optical fiber is the fastest unguided medium.
- C - Transmission in guided media is more secure than transmission in unguided media.
- D - Unguided media transmission can achieve higher data transmission speed than guided media transmission.

- (1) A only                                      (2) B only                                      (3) C only
- (4) C and D only                              (5) A, C and D only

19. Which of the following is false regarding ring topology and bus topology?

- A - In the ring topology, all data travels clockwise only.
- B - Each node in the bus topology is directly connected to only two adjacent nodes.
- C - A linear cable is used to connect all the nodes in the bus topology.

- (1) A only                                      (2) B only                                      (3) C only
- (4) A and B only                              (5) A and C only

20. Match each data communication protocol given from P to T to the corresponding layers of the OSI reference model, labeled 1 to 5.

Protocols	Layers of OSI
P - UDP	1 - Application layer
Q - HTTPPS	2 - Physical layer
R - IP/RIP	3 - Transport layer
S - Ethernet	4 - Network layer
T - MAC	5 - Data link layer

- (1) P - 3, Q - 1, R - 4, S - 3, T - 2                                      (2) P - 3, Q - 2, R - 1, S - 4, T - 5
- (3) P - 2, Q - 3, R - 5, S - 1, T - 4                                      (4) P - 3, Q - 1, R - 4, S - 2, T - 5
- (5) P - 1, Q - 2, R - 3, S - 4, T - 5

21. A message sent from **A** to **B** over the network is converted to a secret code using a software key before sending it to **B**. Then **B** converts it to a state readable again by another logically compatible software key. Which of the following is correct regarding the above situation?
- (1) **A** uses a digital signature to secure the message sent by **A** to **B**.
  - (2) Symmetric key encryption is used in the above process.
  - (3) The message sent by **A** in the ASCII code system is converted to the Unicode system by **B**.
  - (4) **A** encrypts by using the public key and **B** decrypts it using the public key.
  - (5) Asymmetric key encryption is used in the above process.
22. Choose the correct statement/s from the following statements about feasibility studies,
- A - A cost-benefit study is conducted during economic feasibility to evaluate whether the benefits in system development justify the investment.
- B - Operational feasibility determines whether the proposed system will support the organization's strategic objectives.
- C- Organizational feasibility evaluates the willingness and ability of the users to support and use the proposed system.
- (1) A only
  - (2) B only
  - (3) A and B only
  - (4) B and C only
  - (5) All A,B and C
23. A System Analyst analyses three manual information systems P, Q, and R to be automated and presents the following report:
- System A : Requirements are clear and stable and do not allow for changes throughout the project.
- System B : There is a medium to high level of risk and significant changes are expected in the system development process.
- System C : The system requirements are not complex and modules are developed in parallel because the new system must be created in a short period of time
- Which of the following system development models is best for A, B, and C respectively?
- (1) A → Agile,                      B → Spiral,                      C → Waterfall
  - (2) A → Spiral ,                      B → Waterfall,                      C → Rapid Application Development
  - (3) A → Rapid Application Development,                      B → Agile,                      C → Spiral
  - (4) A → Agile,                      B → Rapid Application Development,                      C → Spiral
  - (5) A → Waterfall,                      B → Spiral,                      C → Rapid Application Development
24. Choose the **false** statement from the following statements about Acceptance testing.
- (1) Acceptance testing is performed before the system is accepted by the client.
  - (2) System testing is done after acceptance testing.
  - (3) Internal acceptance testing is also known as alpha testing.
  - (4) Customer acceptance testing is performed by the organization that developed the software.
  - (5) User acceptance testing is performed by the client's customers.
25. Which of the following statements best describes a non-functional requirement of a system?
- (1) Customers should be allowed to transfer money from their accounts to other accounts through the online banking system.
  - (2) An e-commerce website must be able to verify the identity of users after entering a username and password.
  - (3) Even if a school management system crashes, its data should be secure.
  - (4) In a library management system users should be able to search for books based on book name, serial number, or publisher name.
  - (5) Students should be given the opportunity to access learning resources through a learning management system.

26. According to the rules of data flow modeling which is the correct statement regarding data flows in cases A, B, C and D?

A - Between two external entities

B - Between two processes

C - Between an external entity and a database

D - Between two databases

(1) A,B → Direct data flows can exist

C,D → Direct data flows can't exist

(2) A,C → Direct data flows can exist

B,D → Direct data flows can't exist

(3) B,C → Direct data flows can exist

A,D → Direct data flows can't exist

(4) C,D → Direct data flows can exist

A,B → Direct data flows can't exist

(5) B,D → Direct data flows can exist

A,C → Direct data flows can't exist

27. Consider the information system types in List A and the examples given in List B. Identify the most suitable matching between the items in lists A and B.

**List A**

A1 - Transaction Processing System

A2 - Decision Support System

A3 - Expert System

**List B**

B1 - A system that analyzes traffic data and route information and provides the best route between locations.

B2 - A lung cancer detection system using artificial intelligence and knowledge database.

B3 - An online flight booking system.

(1) A1-B1, A2-B2, A3-B3

(2) A1-B2, A2-B3, A3-B1

(3) A1-B3, A2-B1, A3-B2

(4) A1-B2, A2-B1, A3-B3

(5) A1-B3, A2-B2, A3-B1

Question numbers 28 to 31 are based on the following ER diagram

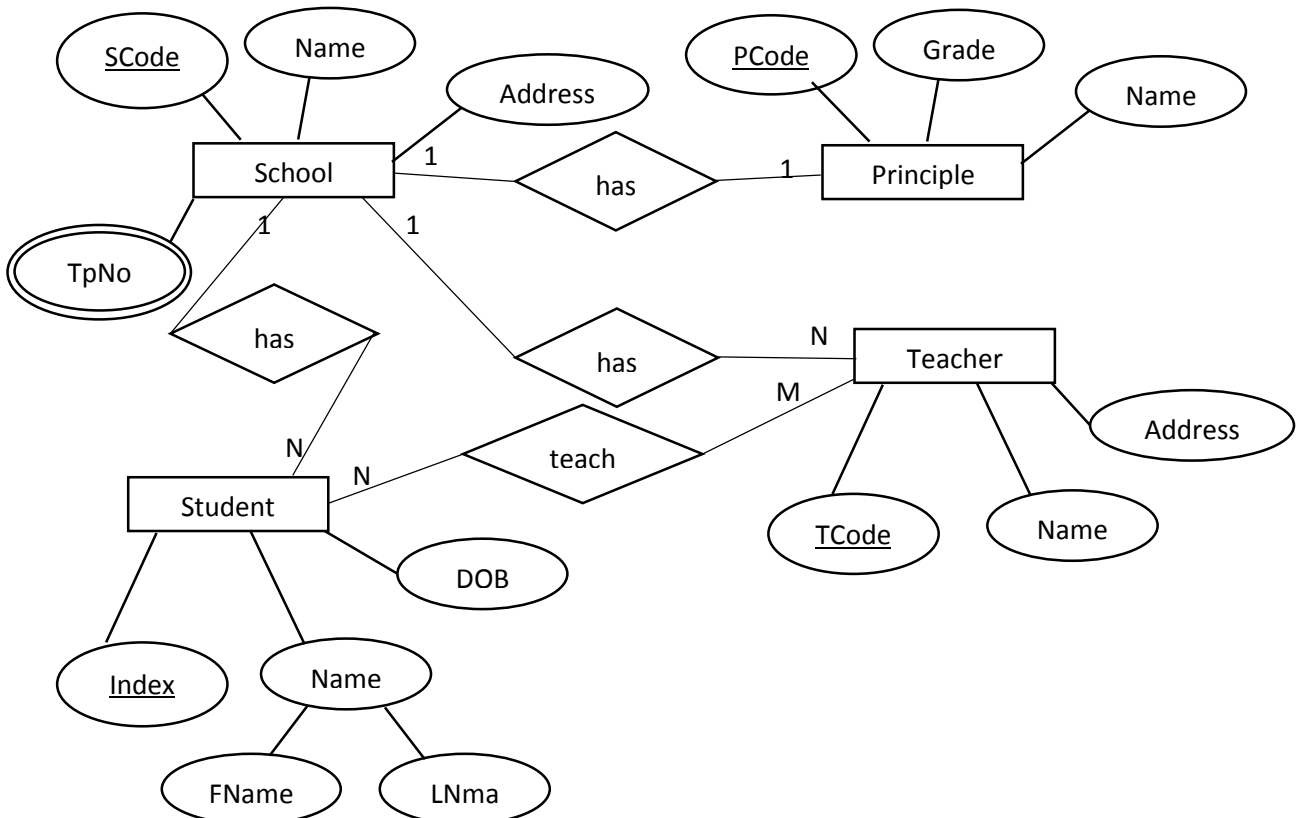

28. What is the correct relational schema for the above ER diagram?
- (1) **School** (SCode, Name, Address, TpNo), **Principle** (PCode, Grade, Name, SCode)  
**Teacher** (TCode, Address, Name, SCode, Index),  
**Student** (Index, FName, LName, DOB, SCode)
  - (2) **School** (SCode, Name, Address), **Principle** (PCode, Grade, Name, SCode) ,  
**Teacher** (TCode, Address, Name, SCode), **Student** (Index, FName, LName, DOB, SCode),  
**School\_phone** (SCode, TpNo), **teach** (TCode, Index)
  - (3) **School** (SCode, Name, Address), **Principle** (PCode, Grade, Name, SCode) ,  
**Teacher** (TCode, Address, Name, SCode), **Student** (Index, Name, DOB, SCode)  
**School\_phone** (SCode, TpNo), **teach** (TCode, Index)
  - (4) **School** (SCode, Name, Address), **Principle** (PCode, Grade, Name, SCode),  
**Teacher** (TCode, Address, Name, SCode), **Student** (Index, FName, LName, DOB, SCode),  
**School\_phone** (SCode, TpNo)
  - (5) **School** (SCode, Name, Address), **Principle** (PCode, Grade, Name, SCode),  
**Teacher** (TCode, Address, Name, SCode), **Student** (Index, DOB, SCode),  
**School\_phone** (SCode, Tpo), **Student\_Name** (FName, LName)
29. Assume that the above relationships are converted to database tables. What should be the output of the following SQL query?
- UPDATE Student SET Name="Kamal Bandara" WHERE Name="Kamal";
- (1) The name Kamal Bandara in the Student table is replaced with Kamal.
  - (2) All data in the Name fields of the Student table will be replaced with Kamal Bandara.
  - (3) Only one recorde is affected by this command at a time.
  - (4) In the name field of the Student table, all data containing Kamal will be replaced with Kamal Bandara.
  - (5) This command does not work correctly.
30. What is the correct SQL command to output all the data of the student with index number S001 along with the name of the school he is studying in?
- (1) SELECT \* FROM Student where Index= "S001";
  - (2) SELECT S.Indxe,Name,DOB,C.Name FROM Student,School WHERE S.SCode=C.SCode AND S.Index= "S001";
  - (3) SELECT Student.Indxe,Name,DOB,School.Name FROM Student,School WHERE Student.SCode =School.SCode AND Student.Index="S001";
  - (4) SELECT S.Indxe,Name,DOB,C.Name FROM Student,School WHERE S.SCode=C.SCode ;
  - (5) SELECT St.Indxe,FName,LName,DOB,Sc.Name FROM Student St,School Sc WHERE St.SCode=Sc.SCode AND St.Index= "S001";
31. Consider the following statements regarding the above *Principal* Entity.
- A - It has a primary key constraint  
B - It must have a foreign key constraint.  
C - It has a domain constraint.
- Which of the above statements is true?
- (1) A only
  - (2) B only
  - (3) A and B only
  - (4) A and C only
  - (5) All A,B and C
32. Consider the following statements regarding normalization.
- A - Value duplication cannot occur in a table existing in the first normalization  
B - A table that exists in the second normalization may have transitive dependencies.  
C - A table that exists in the third normalization may or may not have a composite key.
- Which of the above statements is true?
- (1) A only
  - (2) B only
  - (3) A and B only
  - (4) B and C only
  - (5) All A,B and C

33. Which of the following statements regarding EER-Diagrams is **false**?
- (1) Specialization is a process of separating an entity into several entities through specific attributes
  - (2) Normalization is the process of reducing multiple entities to a single entity through common attributes.
  - (3) Another method for defining attributes with multiple values is included in the EER diagrams.
  - (4) Some components not included in ER diagram are included in EER diagram.
  - (5) EER diagram provides better definition than ER diagram in very complex data based design.

34. A command contained in the Data Manipulating Language (DML) is,
- (1) ALTER      (2) CREATE      (3) SHOW      (4) DROP      (5) SELECT

35. Consider the following statements regarding database relational schema.
- A - It is a diagram that maps a conceptual database to a logical database.  
 B - All constraints applied to data are defined in the logical schema.  
 C - The data and information that can exist in a record is represented through this
- Which of the above statements is true?
- (1) A only      (2) B only      (3) A and B only  
 (4) A and C only      (5) All A,B and C

36. Which of the following statement/s is/are correct regarding the algorithm expressed in the given flowchart?
- A - Input is taken only once from the user.  
 B - The output is always the sum of the previous two numbers.  
 C - When the input is 3 the number of repetitions is 05.
- (1) A only      (2) B only      (3) C only  
 (4) A and B only      (5) A and C only

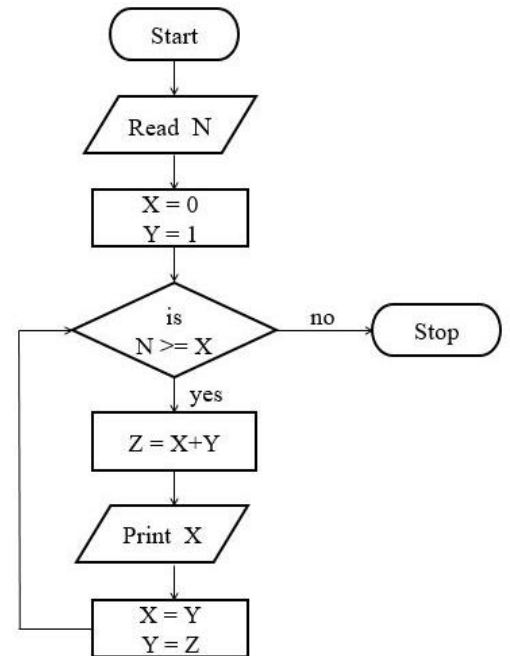

37. What would be the output of the following Python code if the input is 20 ?
- ```

x = int(input( ))
x = (~x + 2 | 4)
print(x)

```
- (1) 13      (2) -13      (3) 19      (4) -19      (5) 23

38. What would be the output of the following Python code?
- ```

def st_list(student):
    for x in student:
        print(x)
students = ['Tom','Rex','Jerry','Xara']
st_list(students)

```

- (1) Tom,Rex,Jerry,Xara      (2) Rex, Xara      (3) 'Tom', 'Rex', 'Jerry', 'Xara'  
 (4) Tom      (5) Rex  
 Rex      Xara  
 Jerry  
 Xara





45. What would be the output of the following HTML code segment?

```
<dl>
  <dt>Colours</dt>
  <ol><li>Red</li><li>Green</li></ol>
  <dt>Numbers</dt>
  <ol><li>one</li><li>two</li></ol>
</dl>
```

(1) Colours

- i. Red
- ii. Green

Numbers

- i. one
- ii. two

(2) Colours

- Red
- Green

Numbers

- one
- two

(3) Colours

- 1. Red
- 2. Green

Numbers

- 1. one
- 2. two

(4) Colours

- Red
- Green

Numbers

- one
- two

(5) • Colours

- Red
- Green

• Numbers

- one
- two

46. Which of the following is the correct example for a Class selector of CSS?

(1) p{color:green; line-height:5px;}

(2) .para{color:green; line-height:5px;}

(3) #para{color:green; line-height:5px;}

(4) .para{color:green; line-height:5px;}

(5) \$para{color:green; line-height:5px;}

47. What will be the output when the following PHP code is executed?

```
<html>
<body>
<?php
  $subject=array("english","Maths","Science");
  for($i=0;$i<3;$i++){
    echo $subject[$i]," ";
  }
?>
</body>
</html>
```

(1) english Maths Science

(2) englishMathsScience

(3) english  
Maths  
Science

(4) 0 english  
1 Maths  
2 Science

(5) 0 english1 Maths2 Science

48. Consider the following PHP code for inserting data into a table in a MySQL database.

```
$sql="INSERT INTO
user(telephone_no,amount_paid)values('$_POST[telephone_no]','$_POST[amount_paid]'
)";
if ($conn->query($sql)==TRUE){
echo"new record created";}
else{
echo "error:" . $conn->error;}
```

Which of the following statements are true about the above code?

- A - It is possible to give data for the fields telephone\_no and amount\_paid in the data table..
- B - The relevant data for \$\_POST[phone\_no] and \$\_POST[paid\_amount] will be entered through an HTML form.
- C - "new record created" is the output of the web browser each time data is entered into the table.
- D - Only the words telephone\_no and amount\_paid are inserted into the data table.

- (1) A only                                      (2) B only                                      (3) B and C only  
(4) C and D only                                (5) A,B and C only

49. Which statement is true about the following code?

```
<style>
#text1 { color:red;
background-color: yellow;
}
</style>
```

- (1) It defines an inline style and uses the CSS 'group selector' concept.
- (2) It defines an inline style and uses the CSS 'id selector' concept.
- (3) It is an example of the CSS 'class' concept and the 'class selector' name is text1.
- (4) It defines an internal style that uses the CSS 'id selector' concept.
- (5) It defines an internal style that uses the CSS 'class selector' concept.

50. www.raabandporter.ca publishes sales of properties owned by the Government of Canada. In addition, advertisements related to the sale of properties of private property owners in different countries are also published on this website for a fee. What are the possible revenue models considered in publishing this website?

- (1) Sales, Advertising
- (2) Sales, Subscription
- (3) Advertising, Subscription
- (4) Affiliate marketing, Subscription
- (5) Sales, Affiliate marketing



වයඹ පළාත් අධ්‍යාපන දෙපාර්තමේන්තුව Provincial Department of Education - NWP  
වයඹ පළාත් අධ්‍යාපන දෙපාර්තමේන්තුව Provincial Department of Education - NWP  
වයඹ පළාත් අධ්‍යාපන දෙපාර්තමේන්තුව Provincial Department of Education - NWP  
වයඹ පළාත් අධ්‍යාපන දෙපාර්තමේන්තුව Provincial Department of Education - NWP  
වයඹ පළාත් අධ්‍යාපන දෙපාර්තමේන්තුව Provincial Department of Education - NWP  
වයඹ පළාත් අධ්‍යාපන දෙපාර්තමේන්තුව Provincial Department of Education - NWP

**තෙවන වාර පරීක්ෂණය - 13 ශ්‍රේණිය - 2023**  
**Third Term Test - Grade 13 - 2023**

**20 S II**

Index No.: .....

**Information And Communication Technology- II**

**03 hours**

Answer **all** questions in **part A** and select only **four** questions from **part B**

- Answer all questions of part A in the **paper itself**.
- The answers should be written in the space provided.

**Part A - Structured Essay**

1. Consider following HTML code segment.

```

1. <html>
2. <body>
3. <!-- section-1-->
4. <h1> welcome your page </h1>
5. <h2><u> student Time Table</u></h2>
6. <!-- section-2-->
7. <table border='1'>
8. <caption> Table1 </caption>
9. <tr><th rowspan='2'> name</th> <th colspan='2'>subject</th></tr>
10. <tr><td> sub1</td><td> sub2</td></tr>
11. <tr><td> praveen</td> <td> ICT</td> <td> English</td></tr>
12. </table>
13. </body></html>

```

(a) Draw the output expected from 6-12 lines as rendered by the web browser.

(b) Rewrite the HTML code given in “note.html” file using Inline CSS method.

File - note.html

```
<html> <head>
<link rel="stylesheet" type="text/css" href="mystyle.css">
</head> <body>
<h1>Cascading style sheets </h1>
<p ><u>Cascading style sheets,</u> <br>fondly referred to as CSS is a
simple design Language intended to simplify the process of making
web pages presentable </p>
</body> </html>
```

File - mystyle.css

```
h1, p { font-family: arial;
        text-align:center;}
p{ color: blue; }
```



(c) Consider the following HTML form which is rendered by a web browser.

**ICT club Registration Form**

Name  Class

**select your gender**

Male  Female

**select your Grade Categorie**

Select your faviort Categories

Graphic  
 Programming  
 Web

The incomplete HTML code for this form is given below. Fill in the blanks of the given code to obtain this form as the output.

```
<html> <head> <title> registration form</title> </head>
<body> <h2> ICT club Registration form </h2>
<form action= 'display.php' method='post'>
<div>..... <input ..... = ..... = 'name'/>
..... <input ..... = ..... = 'class'/>
</div><br>
<p><div>
<h2> select your gender</h2>
<input .....='gender' .....='male'/> Male
<input .....='gender'
.....='female'/>Female
</div><br>
<div>
<b> select your Grade Categorie </b>
```

```

<..... name= 'Grade'>
<.....='Grade 6-9'.....> ..... </.....>
<.....='Grade 10-11'> ..... </.....>
<.....='Grade 12-13'> ..... </.....>
</.....>
</div><br>
<div style="width:450px;">
<fieldset>
<.....> Select your faviort Categories </.....>
<input .....='Catogary1' .....='Graphic'/>.....<br>
<input .....='Catogary2' .....='Programming'/>..... <br>
<input .....='Catogary3 ' .....='Web '/> ..... <br>
</fieldset></div>
<br>
<input type='submit' name='submit' value='submit'>
</form> </body> </html>

```

(d) After completing and submitting the above form, the instruction set given in “display.php” is executed. When completing the form by a student, the name, class, gender and the Grade Category should be displayed. Complete the following code to fulfil that requirement.

```

<?php
if ($_SERVER['REQUEST_METHOD']=="POST")
{ $name= $_.....['.....'];
$class= $_.....['.....'];
$Grade= $_.....['.....'];
$Gender=$_.....['.....'];}
echo "<h2> Your details: <h2>";
echo 'name:-',....., "<br>";
echo 'Class:-', ..... , "<br>";
echo 'Gender:-', ..... , "<br>";
echo 'Grade:-', ..... , "<br>";
?>

```

2. (a) Get the suitable item selected from the given list to complete following statements and write it in the space provided below the statements.
- (i) In the transmission of a signal ..... ❶ ..... occurs due to unnecessary signals generated from external energy signals.
  - (ii) To identify the errors occurring in a communication system, simple methods such as ..... ❷ ..... are used.

- (iii) ..... ③ ..... operates in multiple layers and communicates data using completely different protocols.
- (iv) When a composite signal is transmitted through a media, occurring changes in the form or shape of the sub components of the signal is known as ..... ④ .....

( Network layer, DNS, CSMA/CD, Transport Layer, Gateway , ICMP, HTTP, Noise, Attenuation, Distortion, Parity check, Router, Overall Test )

① .....

② .....

③ .....

④ .....

(b) Select the most suitable items for following statements from the given list.

**List :** { Bit Coin , Credit Card , E-market place , Pure click organizations, Group Purchasing, Virtual Store fronts , Reverse auction, Pure brick organizations }

- (i) The sellers reduce the prices to obtain the sale. (.....)
- (ii) The main purpose of this is to increase the purchasing power as the discounts granted from suppliers are higher due to purchasing in more quantities.(.....)
- (iii) The consumers can purchase goods or services by connecting with the business only through internet. (.....)
- (iv) It is a totally online currency unit that can be used for making payments in a more secured way. (.....)

(c) State accuracy of following expression which are related to the features of Microcontrollers used to actuate and control devices in Internet of Things systems. Mention “correct” if the statement is correct or “wrong” if it is incorrect.

- (i) RAM, ROM, Input/Output ports, have been fixed to another board separately from Microcontroller. (.....)
- (ii) Power consumption is less and can be operated used in external batteries. (.....)
- (iii) The circuits are smaller as peripheral devices are located internally. (.....)
- (iv) Word size is about 8bit/16bit (.....)

3. Consider the following process states transition diagram.

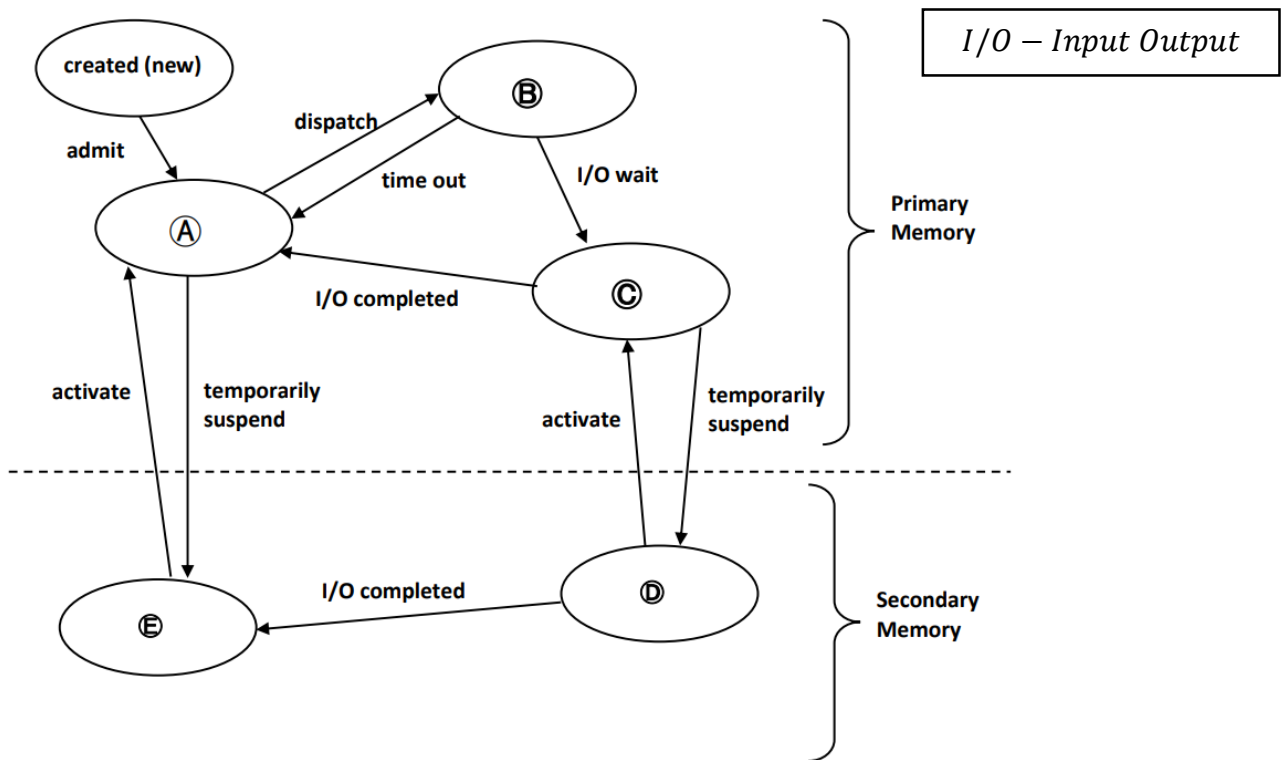

(a) Fill in the blanks given below mentioning the most suitable terms for A, B, C, D and E in the above image.

- A - .....
- B - .....
- C - .....
- D - .....
- E - .....

(b) What are the schedulers used to schedule processes among following process states in the given diagram.

- A to B - .....
- C to D - .....
- created(new) to A - .....

(c) If a memory address contains 24 bits and the memory is two bytes addressable, calculate the memory size.

.....  
 .....  
 .....



(d) In the linked allocation method, when accessing for a file if there is an error in a block next block of the file becomes inaccessible. Briefly describe how this weaknesses is removed by using FAT.

.....

.....

.....

.....

4. (a) It is required to draw a flow chart to calculate the area of a rectangle and output . The length and the width are given as inputs. The algorithm should terminate when an input is less than or equal to zero. Complete the flowchart by writing the suitable statements for empty symbols of the given flow chart.

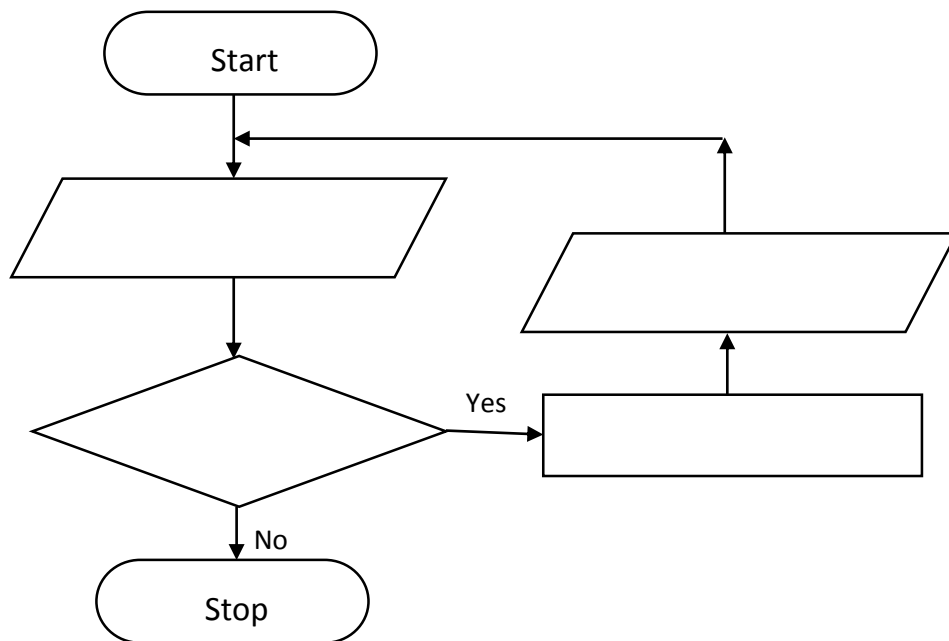

(b) Fill in the blanks of the following python code that displays first ten multiples of a number given as the input.

Note - For examples the multiples of number two can be expressed as 2, 4, 6, ..... 20.

```

num = ..... (input("Enter the number to be multiplied : "))
for i in range (..... , .....):
    print(.....)
  
```

(c) Write the output of following python code.

```
def fib(n):  
    a,b = 0,1  
    while a<n:  
        print(a,end = ' ')  
        a,b = b,a+b  
fib(5)
```

.....  
.....

(d) The content of a text file called “ABC.txt” is “I am learning”.

(i) What is the output of following python code?

```
f=open('ABC.txt','a')  
f.write(" Python")  
f=open('ABC.txt','r')  
y=f.read()  
print(y)  
f.close
```

.....  
.....

(ii) Write the line of code that need to be changed in the code mentioned in (i) above to get only "Python" as output, along with that change.

.....  
.....

**Part - B**

5. (a) Transform the  $\bar{A}BC + A\bar{B}C + ABC\bar{C}$  standard SOP logical expression to the POS logical expression.  
 (b) Following is a description of a certain logic circuit.

This circuit takes 03 input signals. They are named A, B, C respectively. All those inputs are processed through an XOR gate to get the first output (P). That output is again processed with input B through an OR gate to obtain a second output (Q). The second output is again processed with input C through an AND gate to obtain the final output (R).

- (i) Construct the logic circuit diagram that represents the process in this description.
  - (ii) Construct a truth table showing the inputs and output connections for that circuit diagram.
  - (iii) Using the truth table, derive a SOP Boolean expression for the output of the circuit.
  - (iv) Using Karnaugh maps, simplify the Boolean expression obtained in (iii) above.
  - (v) Construct a logic circuit diagram for the simplified Boolean expression, by using a suitable universal gate.
6. (a) Write down the most suitable terms to replace the blanks labelled ❶ to ❷ in the following paragraph related to Open System Interconnection Model (OSI).

Under the Open System Interconnection Model, the data transmission process between computers takes place in .....❶..... layers and bit transmission from one node to another node is done by the .....❷..... layer. Also, ensuring error-free data transfer from one node to another and Logical Link Control as well as Media Access Control are performed in .....❸..... layer. It is the responsibility of the .....❹..... layer to segment the data received from the upper layer by the node to which the data is sent and execute flow and error control operations. The .....❺..... layer controls synchronization and dialogs while the translation of data between different encoding schemes is a function of the .....❻..... layer.

- (b) There is a need to create a computer network connecting four departments of an organization. Those departments are Sales and Purchase Department, Development Department, Accounts Department and Management Department. The 192.200.1.0/25 IP address block is given to the network administrator of the organization, and IP addresses for the respective departments are to be allocated.

In addition to the number of computers in the development department, the network administrator has decided to add a proxy server and provide internet connection to other networks of the organization through that network.

It is required to subnet the above IP address block to satisfy the following requirements. Assume that each department is located in a separate building.

Subnet Number	Department Name	Number of Computers	Servers
D001	Sales and Purchase	15	-
D002	Development	30	Proxy Server
D003	Accounts	12	-
D004	Management	14	-

- (i) Write the first address and the last address of the given IP address block.
- (ii) Write the subnet mask of the given address block in dotted decimal notation.
- (iii) How many host bits are needed to create the required number of subnets?
- (iv) Once subnetting is done, copy the following table to your answer sheet and fill it.

Subnet Number	Network Address	Subnet mask	First usable IP address	Last usable IP address	Broadcast Address
D001	.....	.....	.....	.....	192.200.1.95
D002	192.200.1.0	.....	.....	.....	.....
D003	.....	.....	192.200.1.97	.....	.....
D004	.....	.....	.....	.....	.....

- (c) (i) Write one difference between Symmetric Key Encryption and Asymmetric Key Encryption.
- (ii) Write two threats that malicious software can cause to a computer network.
- (d) (i) Write two functions of a Proxy server
- (ii) What is the functionality of a Domain Name System (DNS) server ?

7. (a) The following figure shows an abstract design of an IoT setup, designed to turn on the lights automatically at night in an unoccupied house and turn off the lights when the sun rises in the morning.

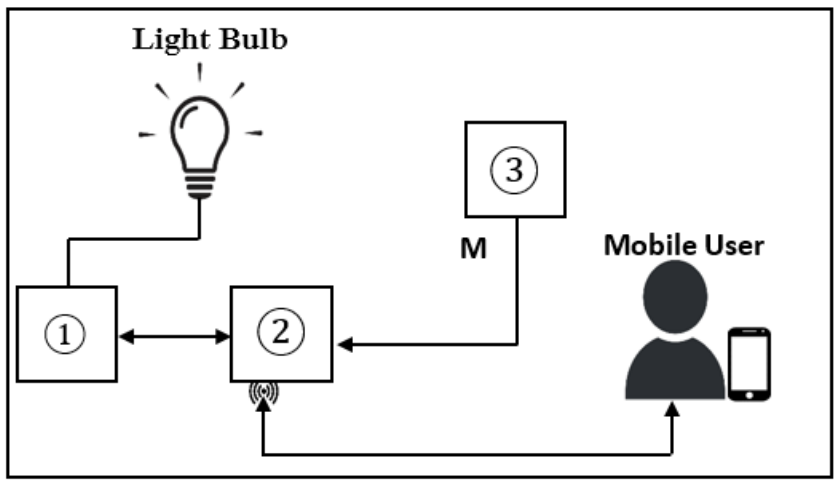

A mobile application is also used to control the switch that activates the lighting system with lights. As shown in the figure, the setup includes a Sensor - **S**, a Current Controller – **C** and a microcontroller - **A** (Arduino Board) with a communication module.

- (i) Match the IoT components labelled as **A**, **C** and **S** to letters of the components described in the above scenario to the corresponding positions (①, ②, ③) in the figure.
- (ii) Explain the reason why the arrow **M** is shown in a single direction.
- (iii) The sensor in the above setup is intended to detect the intensity of sunlight in the environment. Write down the name of the appropriate sensor for this identifier.

(b) Note that the light intensity level (Analog Input) from the sensor mounted in the box is used as a decimal value in the microcontroller.

An algorithm is shown on the right to detect when the light intensity level is in the range of 0 to 63 and turn on the lights, and when the light intensity level is in the range of 64 to 1023, it is a case of sunrise and turn off the lights. Write down the most suitable entries for the places labeled X, Y, P, Q and S.

```

While (true){
  Read Light Intensity Level as M_L
  If [X and Y]
    If Current Controller is ON
      Then Turn off the Current Controller
    End if
  Else
    If [P and Q]
      If [R]
        Then Turn on the Current Controller
      End if
    End if
  End if
}

```

[Note - While(true) block represents the continuous loop function in Arduino.]

(c) Another sensor is intended to be connected to this system to detect the entry of an animal (especially a human) into or near the house. Choose and write the most suitable sensor from the terms given in brackets

{LDR, IR, Motion- PIR, Touch}

(d) A multi-agent system (pictured below) is proposed for this house, considering several benefits. A user can connect with the system through his mobile phone. In that system, if a human behavior is detected by the inputs obtained by several video cameras installed in the house, the photographs are stored in the database called "Observations". The multi-agent system works as follows.

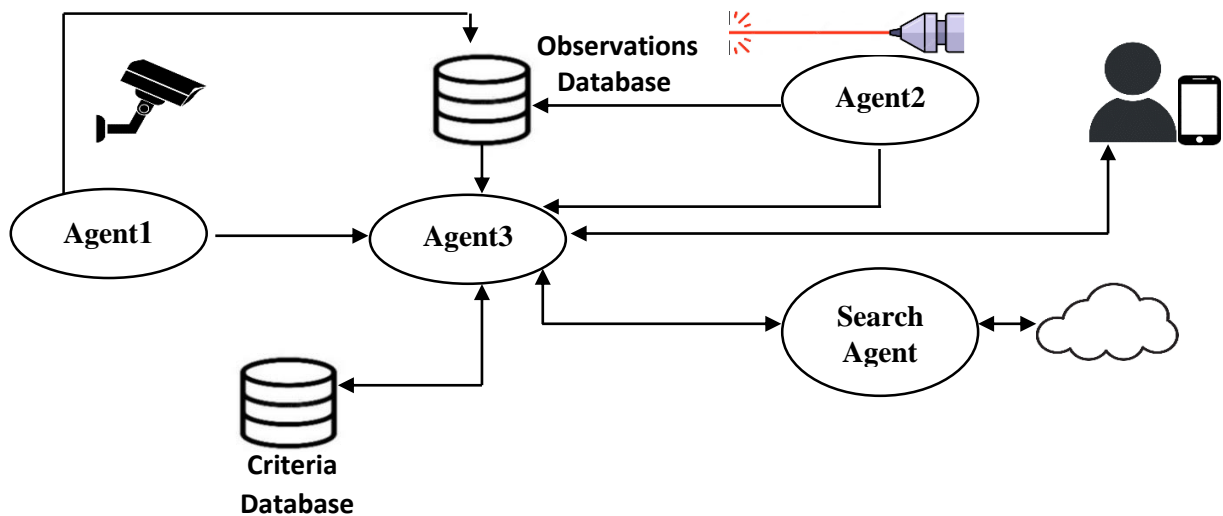

- Agent1 examines the video from the cameras and sends only the images suspected as a human movement to the “Observations” database and informs Agent3 about it.
- Agent2 sends information (time and location etc) about a human movement detected by the laser beam to the “Observations” database and informs Agent3 about it.
- Agent3 compares newly added photos and other information to the “Observation” database with criteria in the “Criteria” database. And if there is information that doesn't match the existing criteria, a search agent is called to check the information.
- Search agent searches relevant information from the Internet. Once the results are fed to Agent3, Agent3 notifies the user if an alert is required, and updates the “Criteria” database with new information.

- (i) In the given scenario who is/are the self-autonomous agent(s)?
- (ii) Write two expected advantages of such a multi-agent system
- (iii) Briefly explain a disadvantageous situation that Agent3 may encounter when calling Search Agent to find new information.
- (e) The owners of this system intend to provide opportunity to be assisted by the agent system described above to the other home owners with CCTV systems in the area.
  - (i) What is the expected business revenue model to be used, if the access to the system and services are going to be provided by doing a monthly or yearly payment?
  - (ii) Write down an advantage and a possible disadvantage to the owners of this system by giving the opportunity to the community nearby to use it.
  - (iii) Briefly explain an action that can be taken by using a new agent, to avoid the potential disadvantageous situation regarding the security of data in the existing system.

8. Note that in the following Python program, a number greater than 2 digits is always given as input.

- (a) (i) What is the output of the following python script if 205 is given as the input?

```

print("Enter a Number: ")
num = int(input( ))

count = 0
while num!=0:
    if count == 0:
        A = num%10
        count = count+1
        B = num%10
        num = int(num/10)

output = A + B
print("output is ", output)
```

- (ii) What would be the modification required, to the output = A + B code line of the above python code if first and last digit of a given positive number to be printed?  
(Example : if the input is 1234, the output should be 14)  
**(Note - It is sufficient to write only the modified, relevant line.)**

- (b) In a school that has two houses namely Olu and Nelum, students are admitted to Olu House if the student admission number is an even number and to Nelum House if it is an odd number. Each entry number starts with letters STU. (Eg: STU200, STU201 etc.)

Develop a Python program to output the house when a student's admission number is input.

**Note - Assume that on each input the entire admission number is entered along with the letters, and then the program ignores STU and uses only the accompanying number to find the house, for calculations.**

For example, when STU200 is input, the output should be Olu.

Part - B

(c) Here is a flowchart set up to output the sum of ten input numbers. Write the expressions that best match the labels 1 to 2 there. Write down the most suitable statements for labels A to G in it. A single process box in this flowchart can have one or more statements.

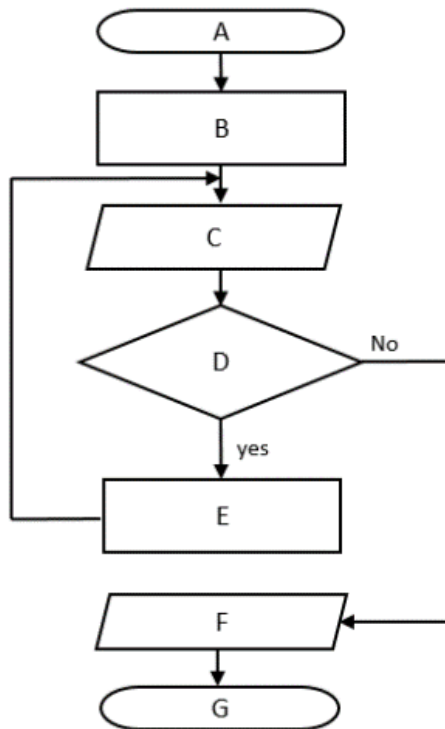

9. (a) Consider the following relational schema that shows the relationship between suppliers of goods and the goods they supply in a particular market. itemNo and supId are the primary keys of Item and Supplier relations respectively.

- Item (itemNo, itemName, price)
- Supplier (supId, supName, address)
- Item\_supplier (itemNo, supId, quantity)
- Supplier\_phone (supId, phoneNo)

Map all of the above relations to a correct Entity Relationship (ER) diagram.

(b) Consider the following database table.

Student\_mark

St_id	Subject_code	Marks	Subject_name
S78452	ICT20	84	Information technology
S78569	ICT20	90	Information technology
S78452	ET85	75	Engineering technology
S78424	BST86	66	Bio Systems Technology

St\_id + Subject\_code is used to identify data uniquely in the above table.

- (i) In which normal form does the above table exist? Explain reasons for it referring to the table.
- (ii) Convert the above table to the next normal form (Writing data is unnecessary)
- (iii) Answer the following questions assuming that the above tables are created in the database using SQL.
  - A - Write the SQL statement to display the different subject names.
  - B - If there are subject names containing part 'formation', then write the appropriate SQL statement to display all of them.
  - C - Write down the output of the following SQL statement.  
 SELECT \* FROM Student\_mark LIMIT 2 ORDER BY Marks;

10. The activities taking place in the organization named *Pizza planet* are described below.

In the store named *Pizza planet*, the customers have to visit the store to pick up the order, though they can order pizza over the phone or by visiting the store. When ordering pizza, customers who are registered in that store should give their phone number to the store's telephone operator and new customers should register by giving their name, address and phone number.

After that, when those customers request for the menu, the phone operator takes the menu details from the menu file and delivers it to their phone. Customer information is stored in a database and information about registered customers can be obtained when their phone number is provided. Information of new customers is stored there.

After the pizza order is received by the operator, the order is stored and the inventory of the required materials (spoon, fork, packing boxes, etc.) is updated by him. The inventory details and the pizza order are given to the kitchen chef who in turn gives the raw material information used from the inventory to the telephone operator to update the inventory. And the pizza processed according to the order is delivered to the cashier. The cashier checks the order register, gets the order details and issues the bill to the customer. After the customer gives the money and the bill, the sealed bill and the balance amount are returned to the customer. After receiving the pizza, prepared according to the orders, they are delivered after checking the bill by the cashier. The cashier updates the sales detail document. When the branch manager requests a sales report from the cashier, the cashier retrieves the inventory details, sales details, and order details from the files and prepares a sales report.

(a) The context diagram for the above activities is given below. Identify and write down the missing *data flow* details related to positions ① to ⑩.

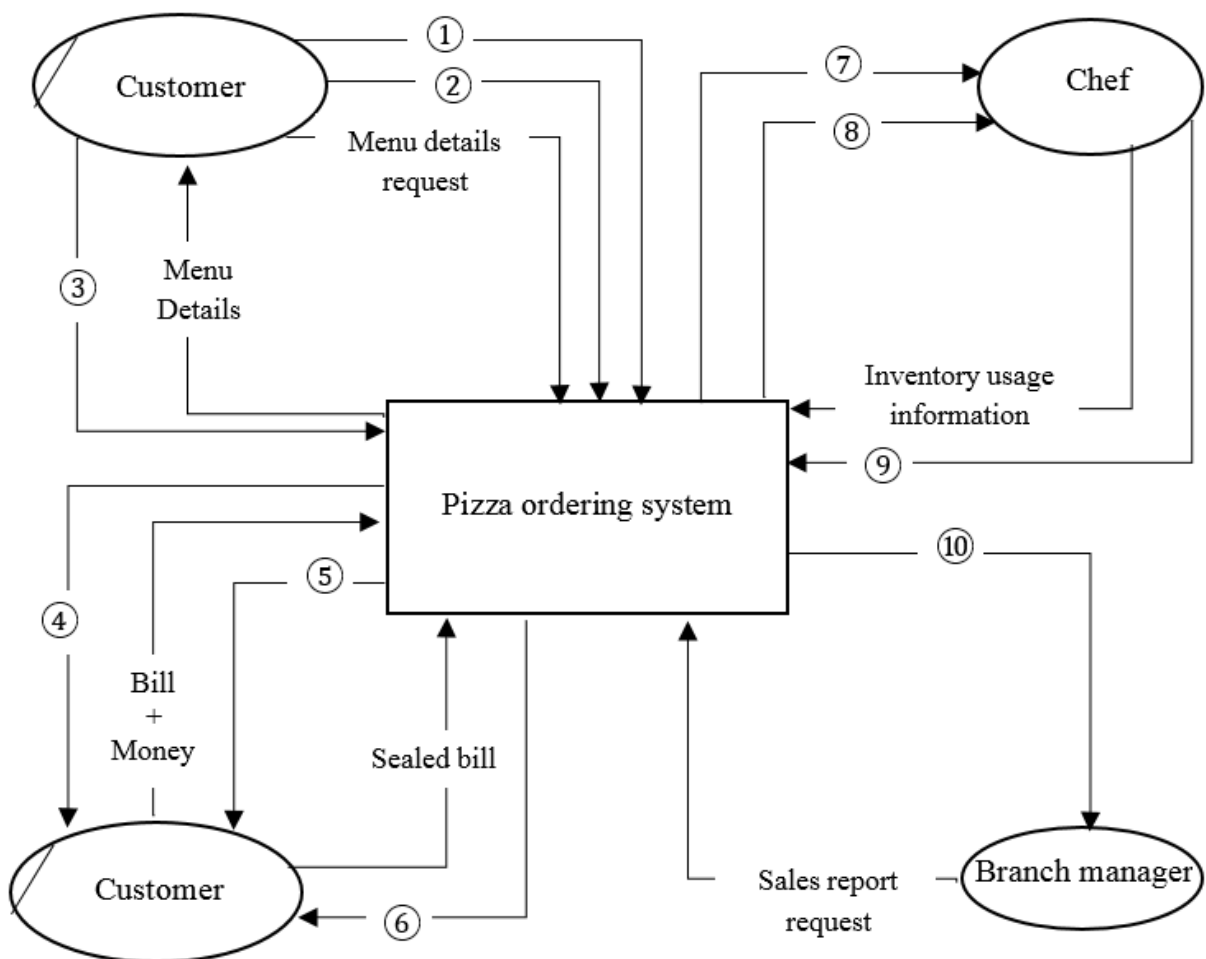



(b) Level 1 of the DFD for the above context diagram is shown below. Identify and write down the relevant data flows and data stores against the labels (A) to (H). (Some data stores are duplicated here)

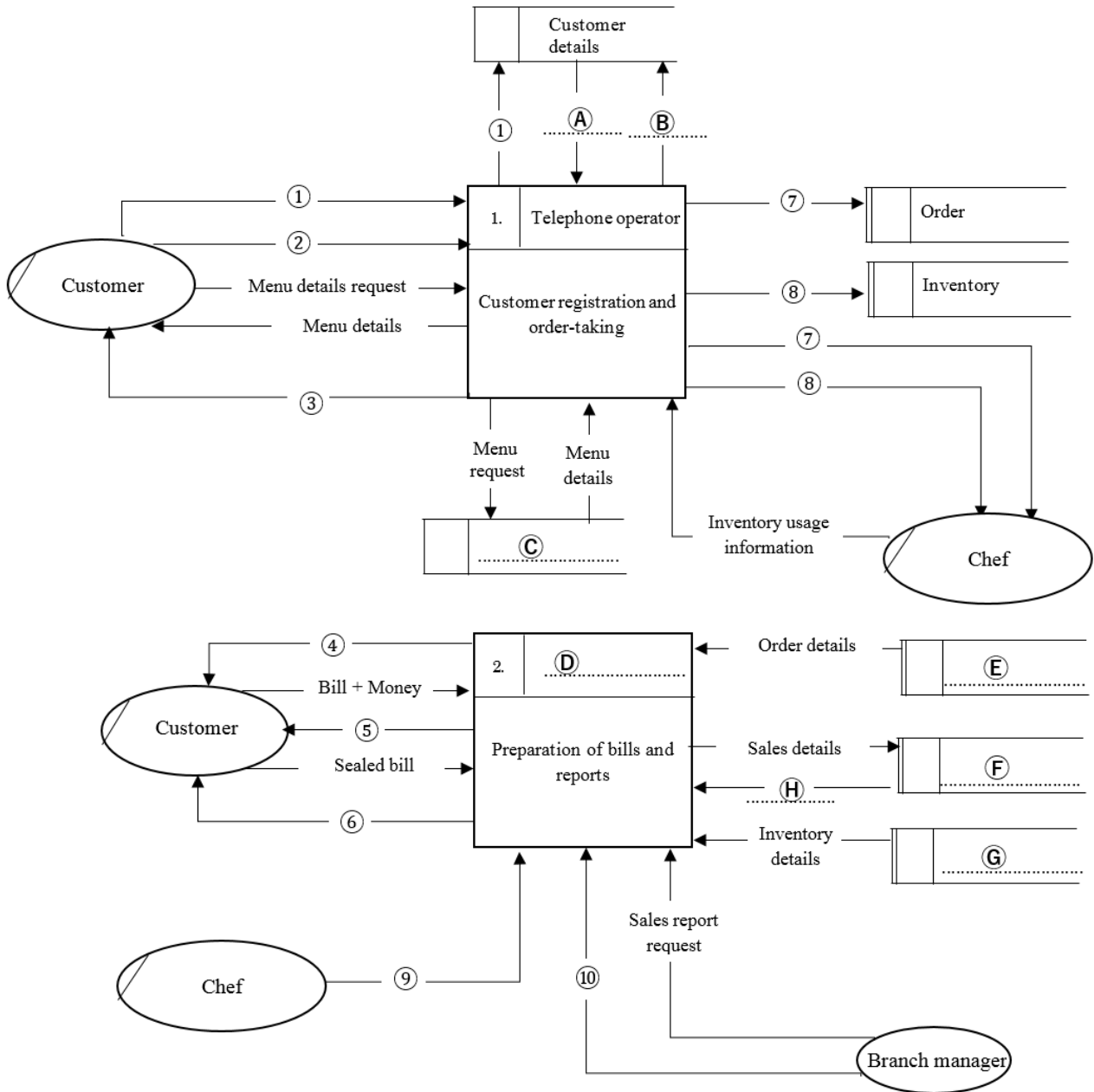

(c) The branch manager of *Pizza planet* says that having an online pizza ordering system can increase its sales. Although the cashier suggests that a commercial-off-the-self-package is appropriate, the branch manager decides that a custom developed software system is better. Explain two possible reasons for the decision of the branch manager by comparing these two software packages.

(d) The following list consists of some of the functional, non- functional and other requirements that a proposed online pizza ordering system should have. Write down the labels of the *functional requirements* within the list.

- A - The system should have a user friendly interface.
- B - The system should work on any web browser.
- C - Users should be given the opportunity to see the type, size and price of pizza.
- D - 10% discount should be given for the first order on every new registration.
- E - The system should authenticate user identity by phone number and password.
- F - Customer information should be preserved in the case of a system crash.
- G - The system should be protected from unauthorized access.